

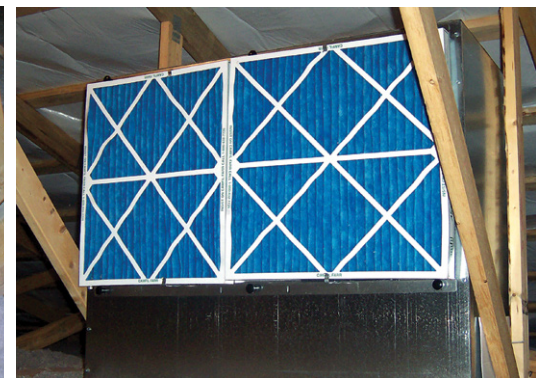

ESSENTIAL RISK MANAGEMENT
AIR FILTRATION SYSTEMS



Pathogen Barrier Filters

The advanced engineering behind the Camfil Pathogen Barrier filters makes it possible to achieve the highest possible airflow while maintaining filtration efficiency throughout the life of the filter.

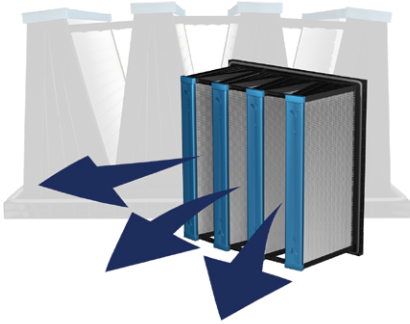

1 Radial Inlet & Outlet

The unique curved form of the air inlet and outlet provides greater open area and less resistance to air flow compared to traditional V-shaped filters. 30% more open area on the filter inlet and 60% more open area on the outlet is a key component to achieving the highest airflow.

2 Media Packs

A fine fiber structure and unique height-to-pleat spacing ratio works in conjunction with the radial inlet and outlet to minimize resistance and maximize air flow. The pleat separators ensure pleat stability to provide continual low energy usage performance.

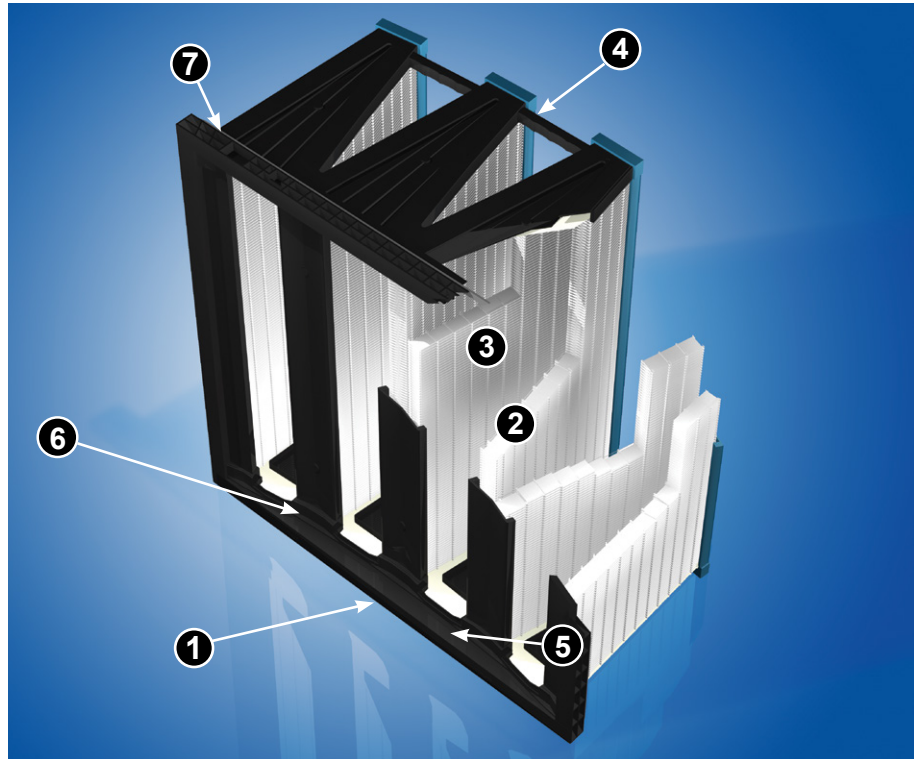
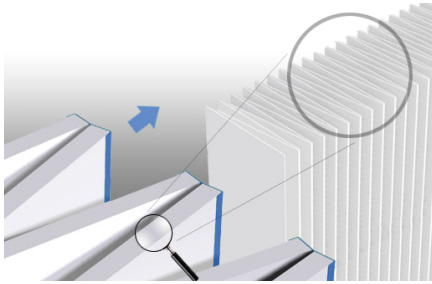

3 5-Star Performance

The Pathogen Barrier Filter is rated as a 5-Star filter through the Energy Cost Index (ECI) program. Based upon a five-star scale, the Energy Cost Index is an indicator of how a filter will perform over time. The best rating, 5-Stars, maintains its efficiency over its life and uses less energy to move air through the filter and is the most energy-efficient, longest lasting filter available.



FastFrame™ Your Filters

FastFrame™ is a holding frame for wall mounted air filtration systems for simple and secure filter installation and replacement. The FastFrame will hold Pathogen Barrier L6 or L9 filters, prefilters or a combination thereof. Aeropleat® III, Aeropleat® IV or other (2 or 4-inch) deep prefilters may be used without fasteners or clips, making installation quick and easy. The FastFrame is available in full size (24" X 24") and three-quarter size (20"x24") meeting the airflow sizing requirements of any application.

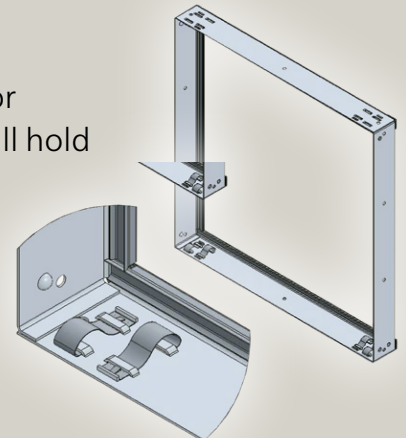



4 Easy Handling

The handles incorporated in the frame allow for ease of handling and prevent damage to the filter media.

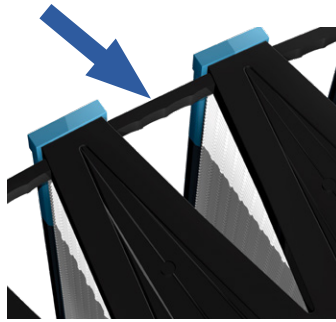

5 Built-In Prefilter Spacer Section

Eliminates blockage of airflow and resultant high pressure drop when a prefilter is mounted directly to the face of the filter. While this problem is common in all V-style filters the problem has been solved through advanced design engineering.

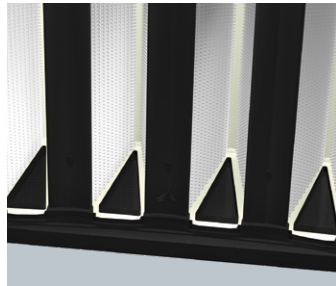

6 Continuous Frame Mold

The Pathogen Barrier is constructed using a single molded front plate with no joints or gaps. Other V-Bed style products use mated frame parts that could potentially create leak paths through the filter.

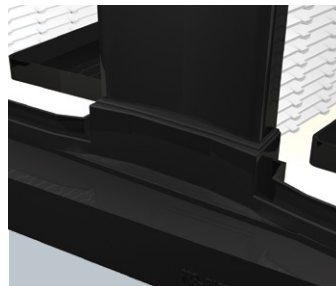

7 Seamless Gasket

Camfil Pathogen Barrier filters feature a seamless molded gasket to maintain the utmost protection from air leakage and contamination.

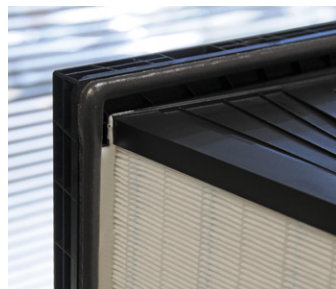

ADDED PROTECTION

As an option, Pathogen Barrier filters are available with an external, powder coated, steel mesh screen. This screen provides additional handling protection to reduce filter damage for optimum filtration.

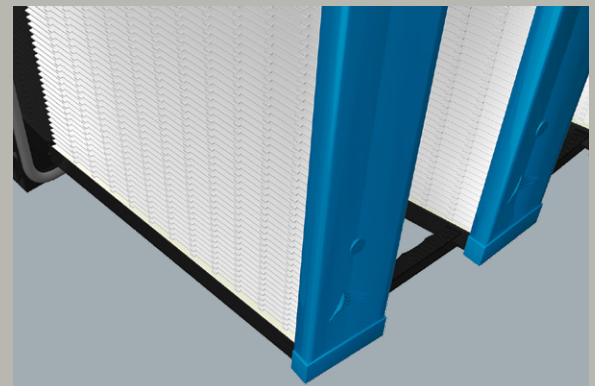
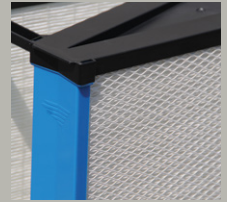

Pathogen Barrier filter media does not rely on electrostatic charge or biocide impregnation to perform. Filtration efficiency does not dissipate with time in use.



Camfil is a registered trademark of Camfil, Sweden. The names Pathogen Barrier and Camfil are used with the permission of Camfil.

Simplify filter installation and maintenance with the FastFrame™ system.

- Final filter and prefilter compression tabs facilitate a clear snap-in-place seal for the final filter and secure the prefilter
- Centering dimples, an integral part of the frame, assist in the alignment of the final or prefilter
- Pre-drilled frame-to-frame installation holes allow fast and secure built-up filter bank assemblies; up to six filters high by any number of filters wide
- 16-gauge all-welded galvanized steel construction



Pathogen Barrier Pro

New hybrid media is five times stronger than standard glass medias with proven sustained L9 efficiency of 95% - Guaranteed!

The new Pathogen Barrier Pro is constructed with a glass/synthetic hybrid media providing 95% particle size capture efficiency for L9 media (85% for L6 media) on the most virulent particle sizes (1 μ m-3 μ m). Unique to other products on the market, this new material delivers the sustained mechanical efficiency of L6 and L9 glass medias.

The Pathogen Barrier Pro provides the strength and durability of synthetic filtration media. This improvement in media strength reduces the possibility of installation and handling damage, further lowering the risk of livestock exposure to airborne contaminants such as PED and PRRS. The efficiency from fine fiberglass and durability from synthetic components provide the best possible protection against outbreaks.

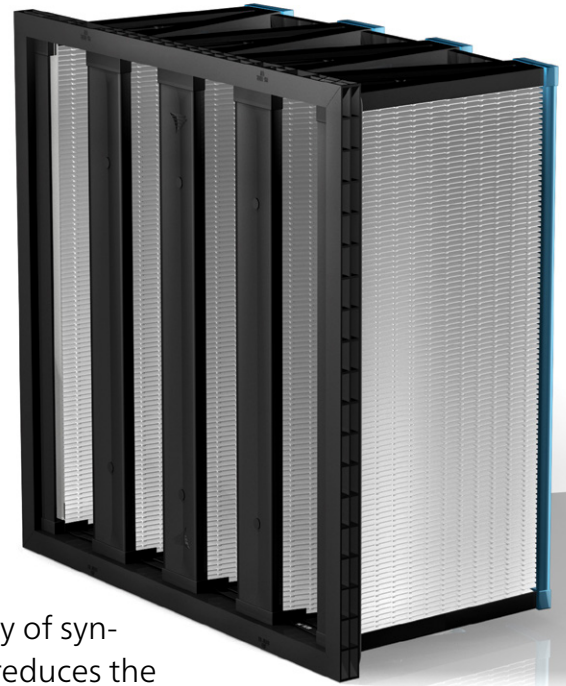

ASK FOR CAMFIL PATHOGEN BARRIER PRO FILTERS!

Camfil is confident in the performance of their filters. In fact, Camfil is the only manufacturer that guarantees continuous rated efficiency for the entire life of the filter. Camfil filters typically stay in service three to four years with no loss in performance.

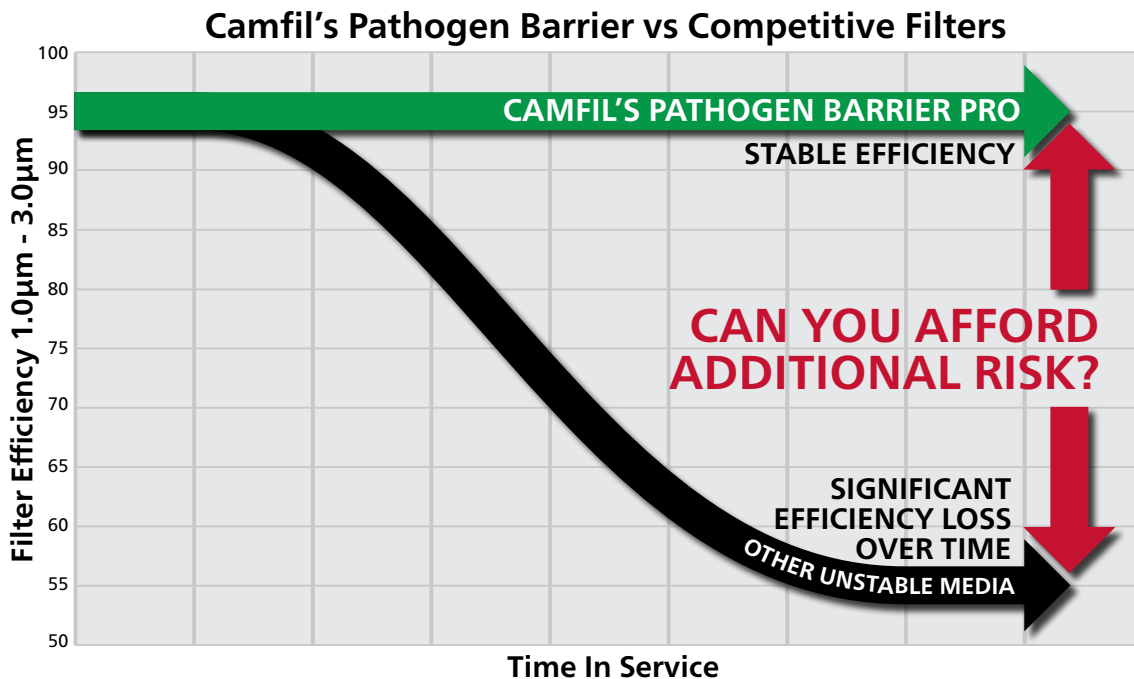



THE RESEARCH

Multiple trials were conducted at the Swine Disease Eradication Center at the University of Minnesota to evaluate the effectiveness of the Pathogen Barrier filters in the prevention of aerosol transmission of the PRRS virus. To perform the test, two independent chambers were constructed and then connected by a duct housing with a fan used to transfer air from one chamber to the other through a Pathogen Barrier filter mounted in the air stream. A number of solutions containing various concentrations of modified live PRRS vaccine were then aerosolized using a cold mist fogger to create a virus cloud in the first chamber. Contaminated air was drawn by the fan from the first chamber, through the filter and then exhausted into the second chamber. Air samples were collected in the second chamber by two Midwest Microtek cyclonic collectors and then tested by PCR for the presence of PRRSV RNA. A minimum of ten repetitions of each trial were performed at each concentration of the virus solution.

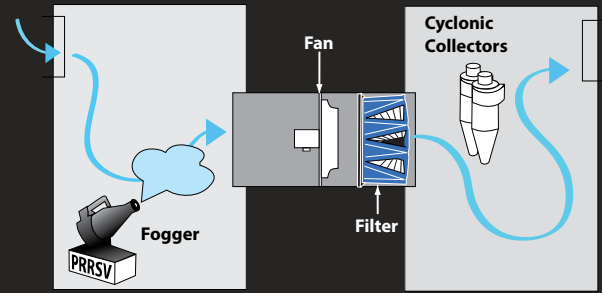

THE RESULTS

L6 Pathogen Barrier filters were proven to be effective in preventing the aerosol transmission of the PRRS virus from the first chamber to the second chamber when using solutions with a concentration up through log six. L6 filters provide minimum resistance to airflow and decreased energy cost.

L9 Pathogen Barrier filters were proven to be effective in preventing the aerosol transmission of the PRRS virus from the first chamber to the second chamber when using solutions with a concentration up through log nine (1,000 times greater than log six). L9 filters provide a higher degree of protection for high value facilities, or facilities in a high risk location.

PRODUCT	PARTICLE EFFICIENCY 0.3 - 1.0M	MODEL	MERV/ MERV-A	NOMINAL DIMENSIONS (INCHES)	ACTUAL DIMENSIONS (INCHES)	AIRFLOW CAPACITY (CFM)*			INITIAL RESISTANCE (INCHES, W.G.)			MEDIA AREA (SQ.FT.)	
L9	Pathogen Barrier	>95%	DU4V-PB-2424-L9	16/16A	24x24x12	23.38 x 23.38 x 11.62	240	550	700	.05	.15	.20	200
		>95%	DU4V-PB-2024-L9	16/16A	20x24x12	19.38 x 23.38 x 11.62	180	413	525	.05	.15	.20	160
		>95%	DU4V-PB-2424-L9 (Screens)	16/16A	24x24x12	23.38 x 23.38 x 11.62	240	550	700	.05	.15	.20	200
		>95%	DU4V-PB-2024-L9 (Screens)	16/16A	20x24x12	19.38 x 23.38 x 11.62	180	413	525	.05	.15	.20	160
L6	Pathogen Barrier	>75%	DU4V-PB-2424-L6	14/14A	24x24x12	23.38 x 23.38 x 11.62	526	1,178	1,468	.05	.15	.20	200
		>75%	DU4V-PB-2024-L6	14/14A	20x24x12	19.38 x 23.38 x 11.62	395	884	1,101	.05	.15	.20	160
		>75%	DU4V-PB-2424-L6 (Screens)	14/14A	24x24x12	23.38 x 23.38 x 11.62	526	1,178	1,468	.05	.15	.20	200
		>75%	DU4V-PB-2024-L6 (Screens)	14/14A	20x24x12	19.38 x 23.38 x 11.62	395	884	1,101	.05	.15	.20	160
L9	PRO Series	>95%	DU4V-PBP-2424-L9	16/16A	24x24x12	23.38 x 23.38 x 11.62	240	550	700	.05	.15	.20	200
		>95%	DU4V-PBP-2024-L9	16/16A	20x24x12	19.38 x 23.38 x 11.62	180	413	525	.05	.15	.20	160
		>85%	DU4V-PBP-2424-L6	15/15A	24x24x12	23.38 x 23.38 x 11.62	315	784	1,020	.05	.15	.20	200
		>85%	DU4V-PBP-2024-L6	15/15A	20x24x12	19.38 x 23.38 x 11.62	250	627	815	.05	.15	.20	160

*NOTE: Performance numbers based on no prefilter.

L6 PATHOGEN BARRIER	AIRFLOW WITH PREFILTER INSTALLED AT PRESSURE IN INCHES OF WATER COLUMN						
	0.10	0.15	0.20	0.25	0.30	0.35	0.40
20" X 24" with 2" PreFilter	410	530	690	800	910	1,020	1,120
24" X 24" with 2" PreFilter	550	710	920	1,070	1,220	1,370	1,500
20" X 24" with 4" PreFilter	380	540	660	770	880	990	1,080

L9 PATHOGEN BARRIER	AIRFLOW WITH PREFILTER INSTALLED AT PRESSURE IN INCHES OF WATER COLUMN						
	0.10	0.15	0.20	0.25	0.30	0.35	0.40
20" X 24" with PreFilter	210	330	450	540	640	730	820
24" X 24" with PreFilter	290	450	610	730	860	980	1,100

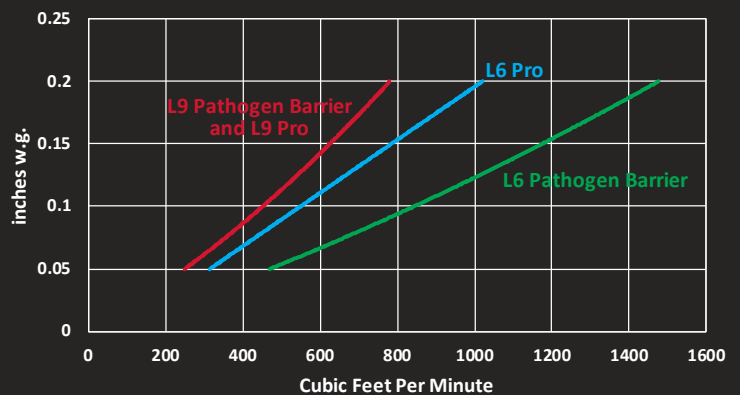

AIR FILTRATION SYSTEMS

FILTER DUCTS

Prefabricated filter ducts fit between roof trusses and adapt two, three, four, six or eight Pathogen Barrier filters to a ceiling air inlet to minimize airflow restriction and allow negative pressure ventilation systems to operate as designed. These sealed ducts are ideal for new construction and converting existing facilities to air filtration.



The poly filter duct system uses a one piece plastic housing with galvanized steel cross members to ensure a quick and hassle free installation.

The media packs and prefilters are held firmly in place with durable clamps and clips that make for easy filter inspection and replacement. Molded tabs in the filter carriage allow easy handling to prevent damage to the filters.



FILTER BANKS

Pathogen Barrier filters can be assembled in a wall bank configuration for neutral and positive pressure ventilation systems as well as adaptation to tunnel and cross ventilated buildings.



No tools are required for filter installation and maintenance.

PREFILTERS

Prefilter units capture larger particles before they reach the filter extending filter life. Two models of prefilters are available, a 2" unit recommended for filter ducts and a more durable 4" unit recommended for applications where filters are exposed to the elements.

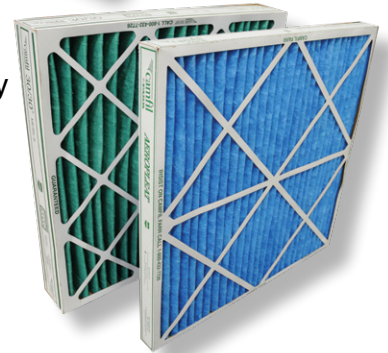

RollSeal[®] Sidewall Doors

AP's RollSeal Sidewall system is the ideal solution for sealing filtered swine facilities. RollSeal features two layers of durable woven polyethylene fabric sealed to the aluminum frame with an industrial hook and loop fastener system. An air space between the layers provides added insulation to conserve energy usage. Combined with an AP electronic control system, RollSeal sidewalls can be fully automated to meet your ventilation needs.



Filter Duct Models

PERFORMANCE AND DIMENSIONS

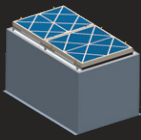

TWO FILTER DUCT

TWO FILTER DUCT ASSEMBLY (30-0662)

Pathogen Barrier	Airflow at pressure in inches of water column				Filters Required		Dimensions with filters and 2" prefilters installed			Weight with Filters
	0.10	0.15	0.20	0.25	24" x 24"	24" x 20"	Height	Width	Length	
L6	960	1,240	1,610	1,870	1	1	28"	28"	45.5"	89 Lbs.
L9	500	780	1,060	1,270						

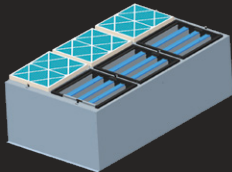

SIX FILTER DUCT - TOP LOAD

SIX FILTER DUCT ASSEMBLY - TOP LOAD (30-1000)

Pathogen Barrier	Airflow at pressure in inches of water column				Filters Required		Dimensions with filters and 2" prefilters installed			Weight with Filters
	0.10	0.15	0.20	0.25	24" x 24"	24" x 20"	Height	Width	Length	
L6	2,880	3,720	4,830	5,610	3	3	28"	84"	45.5"	267 Lbs.
L9	1,500	2,340	3,180	3,810						

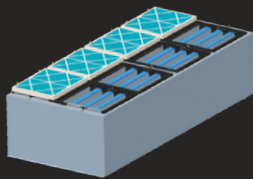

EIGHT FILTER DUCT - TOP LOAD

EIGHT FILTER DUCT ASSEMBLY - TOP LOAD (30-1011)

Pathogen Barrier	Airflow at pressure in inches of water column				Filters Required		Dimensions with filters and 2" prefilters installed			Weight with Filters
	0.10	0.15	0.20	0.25	24" x 24"	24" x 20"	Height	Width	Length	
L6	3,840	4,960	6,440	7,480	4	4	28"	112"	45.5"	712 Lbs.
L9	2,000	3,120	4,240	5,080						

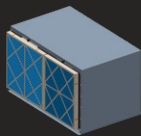

TWO FILTER DUCT

TWO FILTER DUCT ASSEMBLY - LOW PROFILE (30-0802)

Pathogen Barrier	Airflow at pressure in inches of water column				Filters Required		Dimensions with filters and 2" prefilters installed			Weight with Filters
	0.10	0.15	0.20	0.25	24" x 24"	24" x 20"	Height	Width	Length	
L6	960	1,240	1,610	1,870	1	1	27"	31"	45.5"	86 Lbs.
L9	500	780	1,060	1,270						

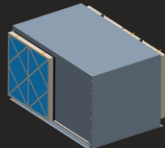

THREE FILTER DUCT

THREE FILTER DUCT ASSEMBLY - LOW PROFILE (30-0803)

Pathogen Barrier	Airflow at pressure in inches of water column				Filters Required		Dimensions with filters and 2" prefilters installed			Weight with Filters
	0.10	0.15	0.20	0.25	24" x 24"	24" x 20"	Height	Width	Length	
L6	1,510	1,950	2,530	2,940	2	1	27"	34"	45.5"	107 Lbs.
L9	790	1,230	1,670	2,000						

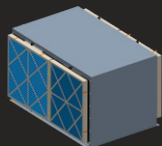

FOUR FILTER DUCT

FOUR FILTER DUCT ASSEMBLY - LOW PROFILE (30-0804)

Pathogen Barrier	Airflow at pressure in inches of water column				Filters Required		Dimensions with filters and 2" prefilters installed			Weight with Filters
	0.10	0.15	0.20	0.25	24" x 24"	24" x 20"	Height	Width	Length	
L6	1,920	2,480	3,220	3,740	2	2	27"	34"	45.5"	116 Lbs.
L9	1,000	1,560	2,120	2,540						

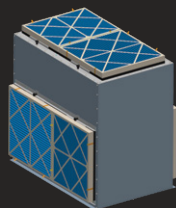

SIX FILTER DUCT

SIX FILTER DUCT ASSEMBLY - LOW PROFILE (30-0806)

Pathogen Barrier	Airflow at pressure in inches of water column				Filters Required		Dimensions with filters and 2" prefilters installed			Weight with Filters
	0.10	0.15	0.20	0.25	24" x 24"	24" x 20"	Height	Width	Length	
L6	2,880	3,720	4,830	5,610	3	3	45"	34"	45.5"	162 Lbs.
L9	1,500	2,340	3,180	3,810						

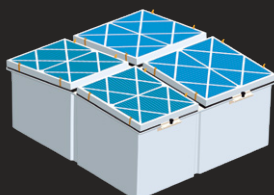

FOUR FILTER DUCT

FOUR FILTER DUCT ASSEMBLY - (30-0974)

Pathogen Barrier	Airflow at pressure in inches of water column				Filters Required		Dimensions with filters and 2" prefilters installed			Weight with Filters
	0.10	0.15	0.20	0.25	24" x 24"	24" x 20"	Height	Width	Length	
L6	1,920	2,480	3,220	3,740	2	2	24"	49.25"	46"	95 Lbs.
L9	1,000	1,560	2,120	2,540						

Performance specifications based on two stages of filtration (2" Prefilter and Pathogen Barrier)
 Two, four, and six filter top load ducts require a minimum of 12" of clearance above the unit to permit installation and replacement of filters. The width of the two filter duct does not include 1.25" (2.50" total) mounting flange.

Specifications subject to change without notice.

PATHOGEN BARRIER EFFICIENCY PERFORMANCE

Guarantee

The Camfil Pathogen Barrier air filter comes guaranteed to maintain rated efficiency while in service. This guarantee eliminates the risk of greater PRRS exposure associated with loss in efficiency or efficacy when choosing or converting to the Pathogen Barrier. The guarantee serves as proof that Camfil stands behind the product's design features and performance capabilities.

The Pathogen Barrier is guaranteed to provide the following:

LIFETIME EFFICIENCY: The Pathogen Barrier uses a special fine fiber media which guarantees the filter will maintain its stated MERV value per ASHRAE 52.2 2017 test standards throughout its service life in a system. This allows consistent and sustainable air within a swine barn and breeding facility. Other products made of highly-charged coarse fiber media have been proven to exhibit a reduction in MERV rating during normal service.

If the Pathogen Barrier does not perform to the above standards, Camfil promises to provide you one free set of replacement filters.

The guarantee is valid for the genuine Camfil-manufactured Pathogen Barrier air filter installed in attics and walls of agricultural livestock barns. The Pathogen Barrier air filter is specifically developed for PRRS and was the first product introduced for this purpose in 2005. Camfil developed this product after extensive scientific testing both internally and in conjunction with industry and academic experts in the swine segment. The genuine Pathogen Barrier filter provides the best available method to limit the spread of the airborne virus. Camfil has more filters installed for this application than any other filter company, and like Camfil's air filtration global ranking, is the number one provider in this segment.

The guarantee will be null and void if any of the following conditions are present:

- Damage due to direct exposure to the elements such as rain, high winds and other events that would cause debris or moisture to impact the media and cause failure.
- Damage to the filter from handling during installation or inspection.
- Damage or decay to the sealing compound from exposure to temperatures outside the stated allowable limits or from use exceeding proper service life.
- Damage due to air velocities through the filter exceeding 500 feet per minute.



Ask About AP's Positive Pressure Filtration Systems

Positive pressure filtration systems provide the greatest protection from infiltration of unfiltered air into the building. The number of filters required can be decreased as the operating pressure of supply fans is increased but energy cost will increase and filter life will decrease accordingly. Talk to your AP dealer for more information on how a AP positive pressure system can work for you.

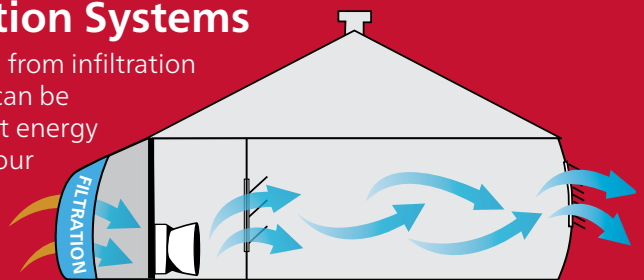

AUTOMATED PRODUCTION SYSTEMS
1004 E. Illinois St. Assumption, IL 62510 USA
Tel: 217-226-4449 Fax: 217-226-3540
Int'l Tel: 217-226-4401
Tech Support: 712-239-1011

For more information on AP's many products and services, contact your local AP representative or visit us online at:
www.automatedproduction.com